

# G.I.KRAFT

---

## Owner's Manual

CE GI35111

---

The equipment is approved by a number of car manufacturers



# Contents

---

1、 Introduction.....	1
2、 Specifications.....	2
3、 Installation.....	3
4、 Precautions.....	4
5、 Controls.....	5
6、 Operation.....	6-7
7、 Repair and Maintenance	
7-1、 Exploded View.....	8
7-2、 Troubleshooting.....	9
8、 Electrical Diagram.....	10
9、 Accessories and Spareparts List.....	11

# 1、 Introduction

---

## Description

Single-phase, battery charger and starter, on wheels, for charging lead-acid batteries With 12/24 v voltage and starting all kinds of cars, vans and light trucks. Equipped with Selector for normal charge, quick charge (boost), quick start and ammeter.

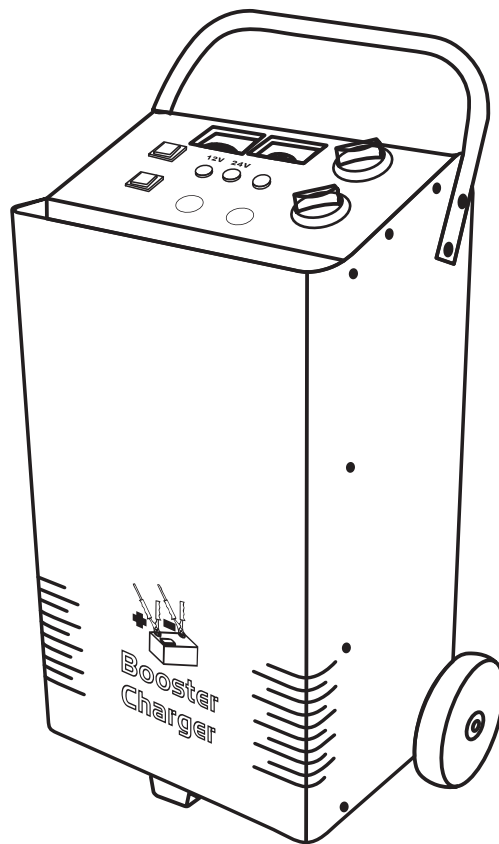

## 2、Specifications

---

### TECHNICAL DATA

MODEL	UNIT	<b>GI35111</b>
MAINS FREQUENCY	Hz	50-60
SINGLEPHASE MAINS VOLTAGE	V	220-240
CHARGING ABSORBED POWER	KW	1.25
STARTING ABSORBED POWER	KW	8.2
CHARGE AND STARTING VOLTAGE	V	12-24
EFFECTIVE CHARGING CURRENT	A	50
RATED CHARGE CURRENT	A	34
START CURRENT	A	200
MAX STARTING CURRENT	A	335
ADJUSTMENT POSITIONS	nr	4
MIN. RATED REFERENCE CAPACITY	Ah	20
MAX. RATED REFERENCE CAPACITY	Ah	800
DIMENSIONS (LxWxH)	cm	330X320X580
WEIGHT	kg	24.1

The specifications in the present catalogue are subjected to modifications or substitution without prior notice.

### 3、 Installation

- 1、 When unpacking ,check to make sure that the product is intact and undamaged .If any parts are missing or broken ,please contact your local distributor as soon as possible
- 2、 Properly install this equipment as following diagram.

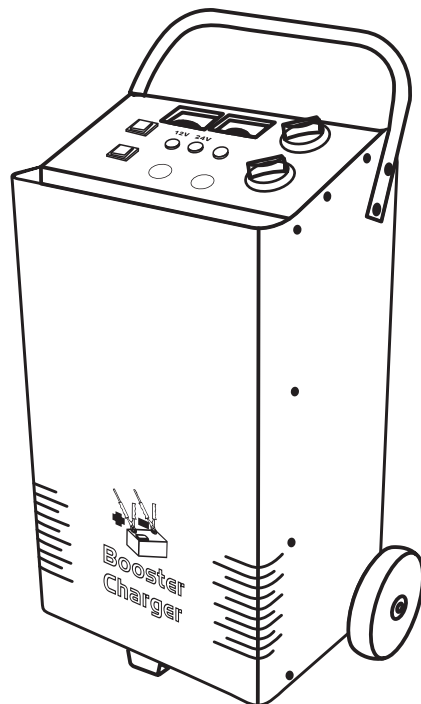

## 4、 Precautions

---

- 1、 Store in a clean and dry location
- 2、 Do not move or operate unit where it could tip
- 3、 Use cart or unit handle to move unit
- 4、 Charging produces explosive gases, Never smoke or allow a spark or flame in vicinity of battery or engine.
- 5、 Operate charger indoor with good ventilation .Do not operate charger to rain or snow or use when wet.
- 6、 Disconnect input power before using charging clips.
- 7、 Electricity arc and spark exist in some electrical component parts of charger such as power switch and relay during normal charging batteries. Keep charger away from inflammables and explosives
- 8、 Do not stop charging suddenly before battery fully charged. Also, never allow clips touch each other.
- 9、 Do not operate charger with damaged cord or plug—replace the cord or plug immediately
- 10、 Never charge a frozen battery.
- 11、 Use only qualified fuse.
- 12、 Clean the battery which will be charged before charging. And check the initial voltage of the battery.
- 13、 Never set power switch to “0” position for charging batteries.
- 14、 Do not charge damaged battery , otherwise it will damage the build-in protection
- 15、 Do not switch charging current while battery is being charged.

## 5、 Controls

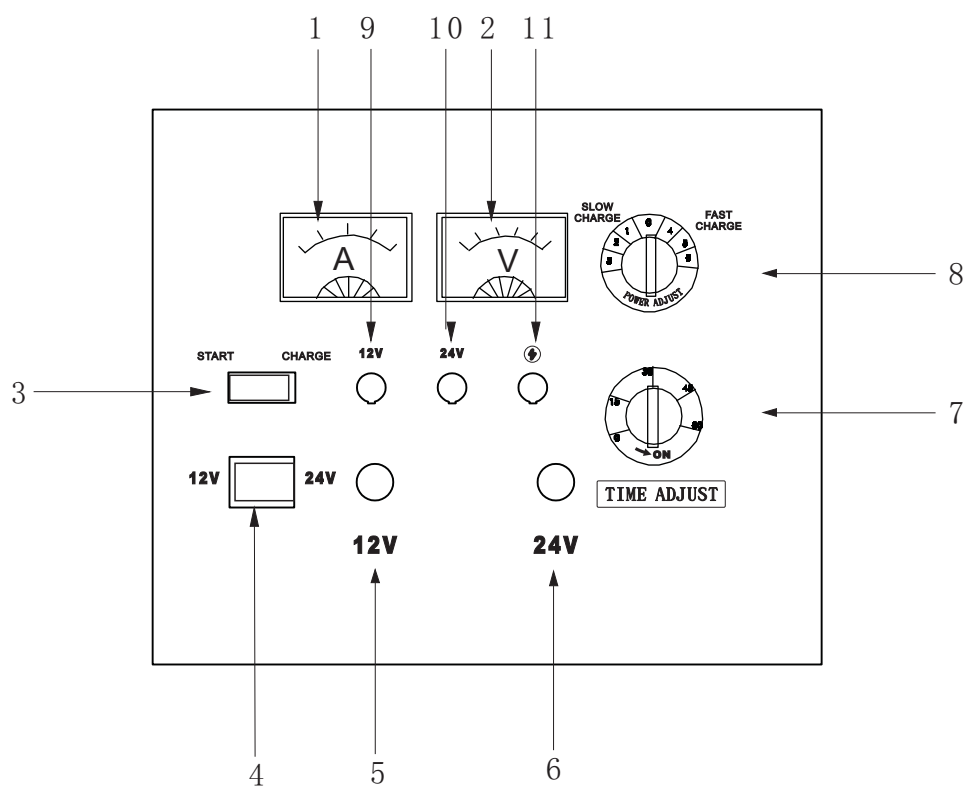

- 1、 Ammeter
- 2、 Voltmeter
- 3、 Charge/Start
- 4、 12V/24V Voltage selector
- 5、 12V output terminal
- 6、 24V output terminal
- 7、 Timer
- 8、 Power adjust
- 9、 12V indicator
- 10、 24V indicator
- 11、 Power indicator

## 6、 Operation

Charging :

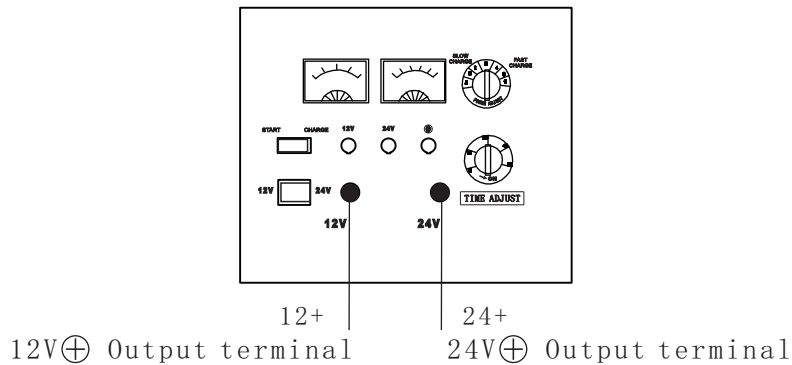

NB! Unplug the charger from the mains before you connect up the battery to the charger.

1) Connecting the charger to battery:

- a) Connect charging cable ⊕ (red) to the 12V ⊕ or 24V ⊕ output terminal on the charger.
- b) Connect charging clip ⊕ (red) to positive post of battery,
- c) Connect charging clip ⊖ (black) to negative post of battery. Turn clips slightly to ensure a good connection.

Warning! Attach the charging clips to the battery the right way round, i, e. with the correct polarity. Ensure that there is a good electrical connection between the charging clips and the battery terminal posts.

- 2) Set voltage selector to voltage of battery: 12V or 24V .
- 3) Set power switch for charge rate desired: position 1, 2, 3 for slow charge, position 4 and 5 for fast charge.
- 4) Plug in battery charger
- 5) Set timer to charge time desired. The charger should now be on and the ammeter showing the rate at which the battery is charging
- 6) When the battery is fully charged, unplug the AC power cord from the outlet
- 7) Turn off charger and remove clip connected to battery post.

Warning! Do not touch charger clips when the charger is on.

The charger can charge more than one battery at the same time ,but the charge time will be extended. Connect as the below diagram shown:

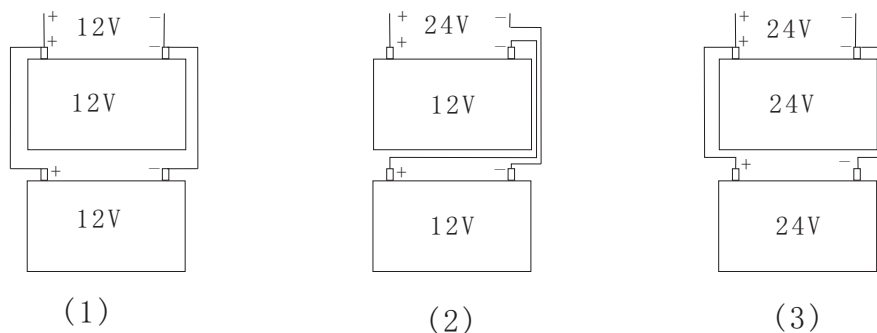



Jump-starting:

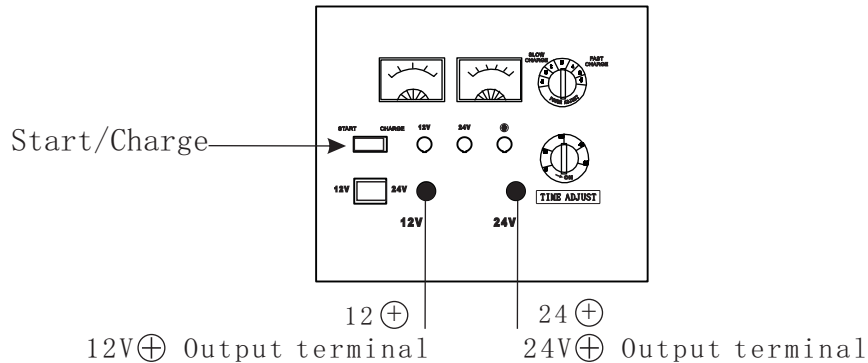

NB! Unplug the charger from the mains before you connect up the battery to the charger.

1) Connecting the charger to battery:

- a) Connect charging cable ⊕ (red) to the 12V ⊕ or 24V ⊕ output terminal on the charger.
- b) Connect charging clip ⊕ (red) to positive post of battery,
- c) Connect charging clip ⊖ (black) to negative post of battery. Turn clips slightly to ensure a good connection.

Warning! Attach the charging clips to the battery the right way round, i. e. with the correct polarity. Ensure that there is a good electrical connection between the charging clips and the battery terminal posts.

- 2) Set voltage selector to voltage of battery: 12V or 24V .
- 3) Set power switch to position 6 for jump-starting.
- 4) Set timer to ON
- 5) Plug in battery charger
- 6) Crank the engine in the normal manner. DO NOT CRANK FOR MORE THAN 15 SECONDS. Check car's owners manual for recommended cranking time limit.
- 7) When the engine has started, unplug the AC power cord from the outlet
- 8) Turn off charger and remove clip connected to battery post.

Warning! Do not touch charger clips when the charger is on.

NB: For high power engine, fast charge the battery for 15mins before jump-starting to get the best result .For diesel engines,pre-heat spark plug before jump starting.

If charger can not jump start engine, check to make sure the specification of input power cord to meet manufacturer's requirement and the connections of charging cables.

## 7、Repair and Maintenance

### 1、Exploded view

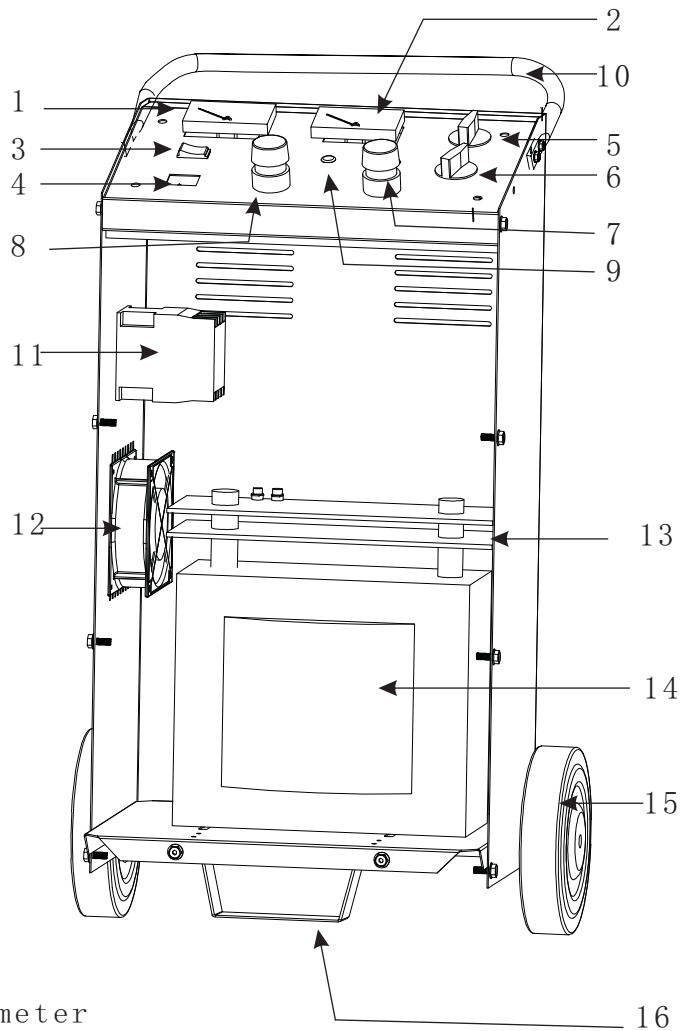

- 1、Ammeter
- 2、Voltmeter
- 3、Charge/Start
- 4、12V/24V Voltage selector
- 5、Power adjust
- 6、Time adjust
- 7、24V output terminal
- 8、12V output terminal
- 9、Indicator
- 10、Handle
- 11、Contactor
- 12、Fan
- 13、Rectifier
- 14、Main transformer
- 15、Wheel
- 16、Front stand

## 2. Troubleshooting





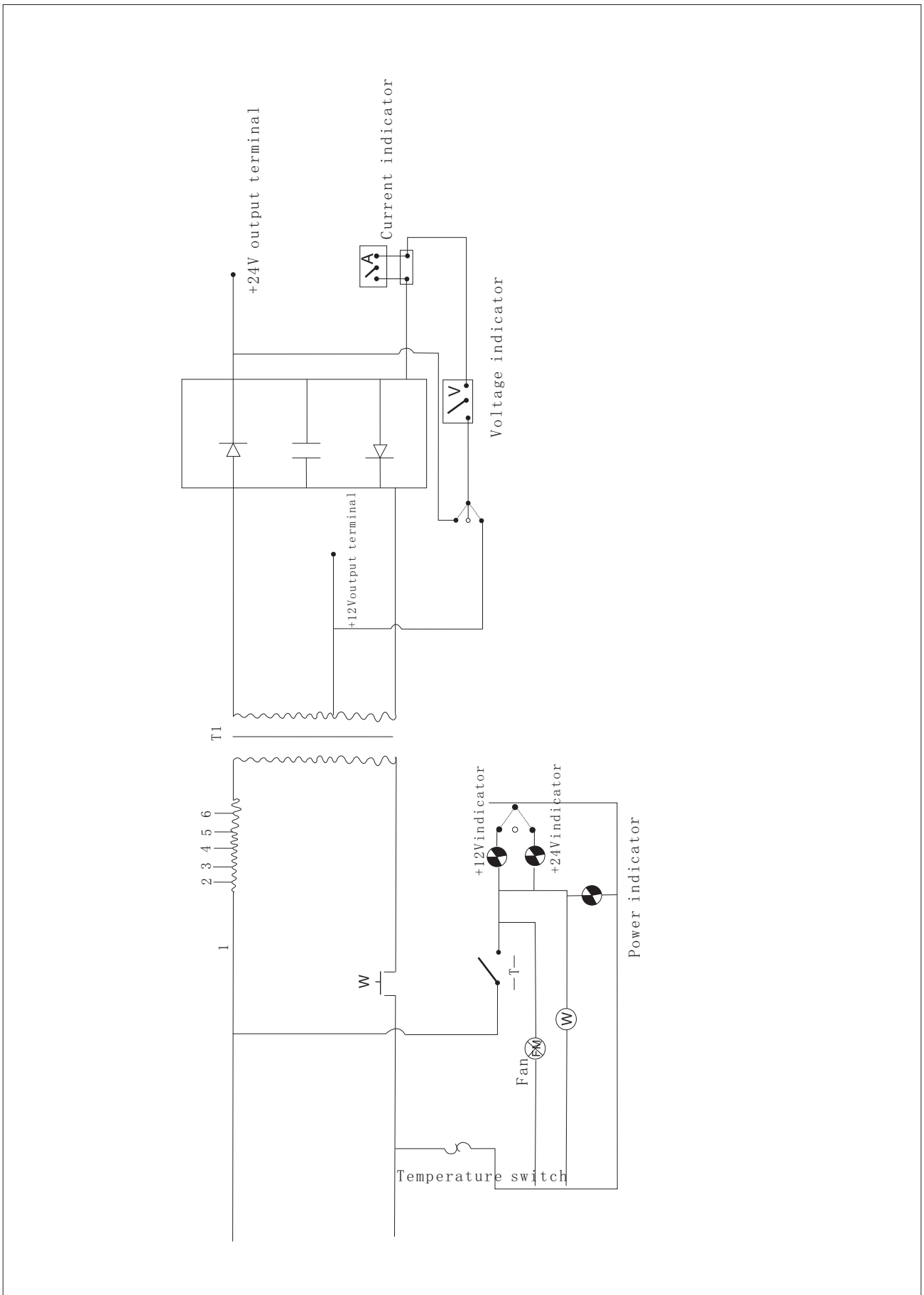





Trouble	Probable cause	Remedy
No input power	(1) incorrect input power connection (2) Power switch in "off" position	(1) Check input power connection (2) Turn power switch to "on" position
Timer does not work	(1) Charging time has not adjusted (2) Timer damaged	(1) Adjust charging time (2) Replace timer
Not enough electricity power of charged Battery	(1) Improperly connect work cables or clamps (2) Not enough charging current (3) Not enough charging time (4) Excess charge rate of battery capacity	(1) Check cables connections and tighten clamps (2) increase charging current (3) increase charging time (4) Check correct charge rate for the battery being charged
Charger stops working while operating	(1) Timer reaches preset time (2) Charger over heat	(1) Adjust timer (2) Wait for charger temperature cool down
Voltmeter does not work	(1) Switches in "off" position (2) 12V/24V switch in neutral	(1) Turn on power, adjust timer and current (2) Select 12V or 24V
Ammeter does not work	(1) No output current	(1) Ammeter works while under loading only
Cannot charging battery	(1) Incorrect cables connections (2) Switches in "off" position (3) Battery had been damaged	(1) Check cables connections (2) Adjust switches to correct position (3) Check battery

## 8、Electrical Diagram



## 9、Accessories and spareparts list

### Accessories and spareparts list

 Contactor NO. S001	 Front stand NO. S002
 Amperage switch NO. S003	 Rectifier NO. S004
 Power switch NO. S005	 Timer NO. S006
 Voltmeter NO. S007	 Wheel NO. S008
 Ground clamp NO. S009	 Ammeter NO. S010
 Output cord NO. S011	

#### Remarks:

- 1) Optional orders for above accessories and spareparts are available.
- 2) Model and parts number required when ordering parts from your local distributor or service agency.