

**LAUNCH**

TLTE32SCA/ TLTE40SCA

Two Post Lift User's Manual

Launch Shanghai Machinery Co., Ltd.

Copyright reserved! Without the written agreement of Launch Shanghai Machinery Co., Ltd. (hereinafter called "Launch"), no company or individual is allowed to copy and backup this manual in any form (electronic, mechanical, photocopy, recording or other forms). This manual is specifically designed for the use of Launch product, and our company doesn't undertake any responsibility for various consequences caused as a result of applying it to the guidance of operating other equipment.

In case of the equipment damage or loss due to the accident of the user himself or third party, abuse or misuse of this equipment, unauthorized change and repair of this equipment, or not conforming to the operation and maintenance requirement of Launch, Launch and its branches won't undertake any responsibility for the expenses and expenditures generated.

For the equipment damage or problem caused as a result of using other optional accessories or consumables instead of original Launch product or its recognized product, Launch won't undertake any responsibility.

Official statement: The purpose of other- product- names mentioned in this manual is to describe how to use this equipment. Their registered trademarks still belong to the

original companies.

This equipment is for the use of professional technical personnel or maintenance personnel.

## Registered Trademark

Launch has registered its trademark in China and several foreign countries, with the symbol of LAUNCH. Other trademarks, service symbol, domain name, icon, and company name of Launch mentioned in this manual belong to the property of Launch and its subsidiary companies. In the countries where Launch's trademark, service symbol, domain name, icon and company name haven't been registered, Launch declares its ownership on such unregistered trademark, service symbol, domain name, icon and company name. The trademarks of other products and company names mentioned in this manual still belong to the originally registered companies. Without prior written agreement of the owner, nobody can use the trademark, service symbol, domain name, icon and company name of Launch and other companies mentioned in this manual. If you have any question, please visit website of Launch: <http://www.cnlaunch.com> or write to Sales Dept. of Launch Shanghai Machinery Co., Ltd. at No. 661 Baian Road, International Automobile City Auxiliary Parts Park, Anting Town, Jiading District, Shanghai City to contact Launch.

## Insured by PICC

## PRECAUTION

### WARNING



- This instruction manual is an essential integral part of this product. Please read all instructions.
- Properly keep this manual for use during the maintenance.
- Use only as described in this manual. Use only manufacturer's recommended adapters.
- This equipment is only used for its clearly designed purpose, and never use it for other purposes.
- The manufacturer is not responsible for any damage caused as a result of improper use or use it for other purposes.
- Always wear safety goggles.

### IMPORTANT SAFETY

### INSTRUCTIONS

**When using your garage equipment, basic safety precautions should always be followed, including the following:**

- Only the qualified personnel having undergone special training can operate this machine. Without the permission of the manufacturer or not following the requirement of the manual, any changes in the machine part and in the usage scope may cause direct or indirect damage to the machine.
- Don't keep the lift in the extreme temperature and humidity environment. Avoid installation beside the heating equipment, water tap, air humidifier or stove.
- Prevent the lift from contacting large amount of dust, ammonia, alcohol, thinner or spray adhesive, and prevent it from rain shower.
- Always disconnect equipment from electrical supply when not in use. Never use the cord to pull the plug from the outlet. Grasp plug and pull to disconnect.
- To reduce the risk of electric shock, do not use on wet surfaces or expose to rain.

- To reduce the risk of fire, do not operate equipment in the vicinity of open containers of flammable liquids (gasoline).
- During the machine operation, non-operators should be kept away from the machine.
- Do not operate equipment with a damaged cord or the equipment has damaged or lost parts, until examined by a qualified serviceman.
- The lift can't be overloaded. The rated load of the lift is already marked on the nameplate.
- Please don't raise the lift when there are people in the vehicle. During the operation, the customer and spectators shouldn't stand in the lifting area.
- Keep the lifting area free from obstacle, grease, machine oil, garbage and other impurities.
- Position the swing arm of the lift, making it contact the lifting point as recommended by the manufacturer. Raise the carriage and confirm the lifting pad and vehicle are closely contacted. Raise the carriage to the appropriate working height.
- For some vehicles, the parts dismantling (or installation) will cause severe deviation of the center of gravity, leading to unstable vehicle. The support is needed to keep the balance of the vehicle.
- Before moving the vehicle away from the lifting area, please position the swing arm and lifting pad back away to avoid blockage during the movement.
- Use appropriate equipment and tools as well as safety protection facilities, e.g. working uniform, safety boot, etc.
- Pay special attention to various safety marks attached to the machine body.
- Keep hair, loose clothing, fingers, and all parts of body away from moving parts
- Pay special attention not to dismantling the safety unit of the machine or making it not functioning.
- The hydraulic oil used for this lift is N32 or N46. Please refer the safety data of grease and oil shown in the manual.
- Adequate ventilation should be provided when working on internal combustion engines.
- **Launch Shanghai Machinery Co., Ltd. is dedicated to continuously improving the product quality and upgrading the technical spec. They are subject to change without notice.**

### Caution labeling exemplify

(1) Read operating and safety manuals before using lift!

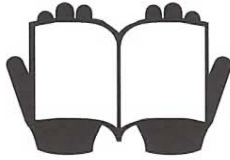

(6) use LAUNCH commend lifting points!

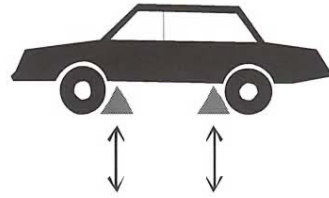

(2) Proper maintenance and inspection is necessary for safe operation!

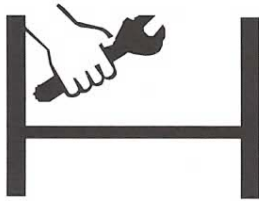

(7) use bracket to help disassembly or installation!



(3) Don not operate a damaged lift!



(8) Auxiliary adapters would reduce load capacity!

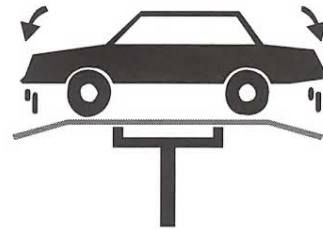

(4) Lift can be used by trained operators ONLY!



(9) keep area clear!



(5) only Authorized personnel can be in the lift area!



(10) the central of gravity should be between two arms!



(11) keep the area clean!

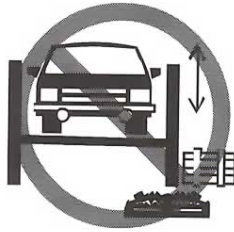

(14) keep feet clear when lowering!



(12) do not shake the vehicle!



(15) When lifting or lowering, don't stand under the lift!



(13) do not lift single side of vehicle!



# Table of Contents

<b>1 Outline</b> .....	1
1.1 Model Description.....	1
1.2 Purpose.....	1
1.3 Functions and Features.....	1
1.4 Technical Specifications.....	1
1.5 Environmental Requirement.....	1
<b>2 Lift Structure</b> .....	2
<b>3 Operation Description</b> .....	4
3.1 Precautions for Operation.....	4
3.2 Preparation before Operation.....	4
3.3 Inspection before Operation.....	4
3.4 Lifting the Vehicle.....	5
3.5 Lowering the Vehicle.....	5
<b>4 Hydraulic and Electrical System of the Equipment</b> ..	6
4.1 Hydraulic System of the Lift.....	6
4.2 Electrical System of the Lift.....	7
<b>5 Solutions to FAQ</b> .....	9
<b>6 Repair and Maintenance</b> .....	10
<b>7 Storage and Scrap</b> .....	11
7.1 Storage.....	11
7.2 Scrap.....	11
<b>Grease and hydraulic oil for lift</b> .....	12
<b>Warranty</b> .....	13

# 1 Outline

## 1.1 Model Description

Model	Description	
TLTE32SCA	3.2t	clear-floor two post lift
TLTE40SCA	4.0t	clear-floor two post lift

## 1.2 Purpose

This machine is applicable for the lifting of various small and medium-sized vehicles with total weight below 3.2t/4.0t in garage and workshop.

## 1.3 Functions and Features

- The cable and oil pipe are fully concealed, with decent and elegant appearance.
- Designed based on the international standard, meeting the demand of the garage and workshop.
- Top limit switch, effectively protecting the vehicle from

Basic parameters of the equipment:

Model	Rated load T (Lb)	Lifting height mm (in)	Rising time Sec	Descending time Sec	Equipment net weight	Passage width mm (in)	Machine width mm (in)	Machine height mm (in)
TLTE32SCA	3.2 (7000)	1950 (76.8)	50	40	660kg 1455 lb	2336 (92)	3270 (128.7)	3840 (151.2)
TLTE40SCA	4 (9000)	1950 (76.8)	50	40	750kg 1653 lb	2486 (97.9)	3420 (134.6)	4810 (189.4)

### Noise:

Working noise: ≤80dB(A)

### Power unit:

Working pressure: 16Mpa (TLTE32SCA)

18Mpa (TLTE40SCA)

Electrical parameters of the machine:

### Motor: (selected by client)

Single phase: 110V/60Hz 2.2kW; 220V/50Hz 2.2 kW

Single phase: 200V/60Hz 2.2 kW

Three phase: 380V/50Hz 2.2 kW

overhead collision.

- Dual hydraulic cylinders drive, stable lifting and lowering.
- Electromagnetic full-scope safety lock.
- Lowering electrically, safe and simple in operation.
- Adopt two steel cables for equalization, force two carriages to move synchronously, and effectively prevent the vehicle from tilting.
- Lowest height of lifting pad is 110mm, good for repairing low chassis or low profile car.

## 1.4 Technical Specifications

## 1.5 Environmental Requirement

Working temperature: -5°C ~+40°C

Transport/storage temperature: -5°C ~+40°C

Relative humidity: Temperature +30°C, relative humidity 80%

Height above sea level: No more than 2000m

## 2 Lift Structure

The structure of TLTE32/40SCA is as shown in Fig. 1:

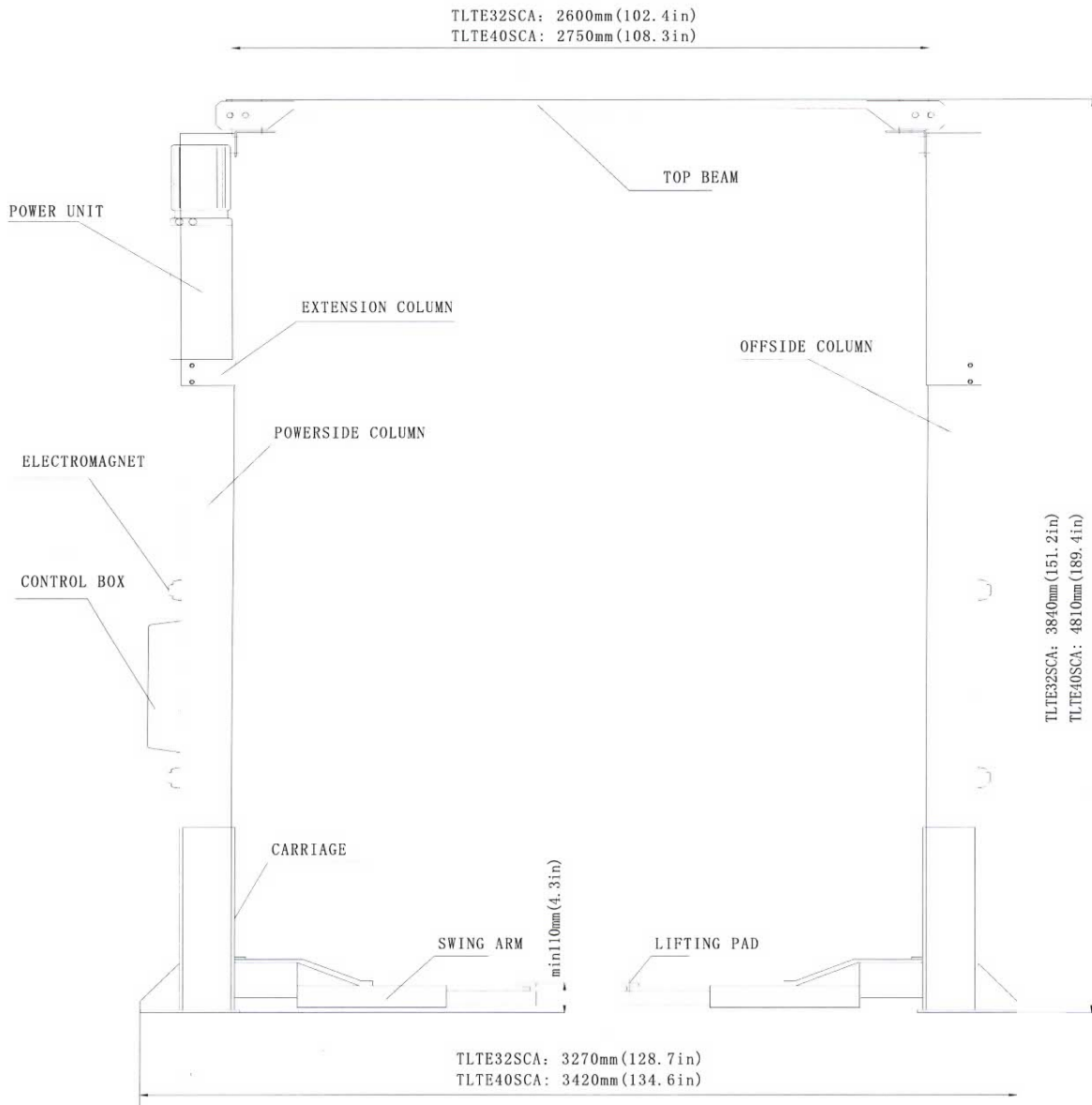

Fig. 1



TLTE32SCA

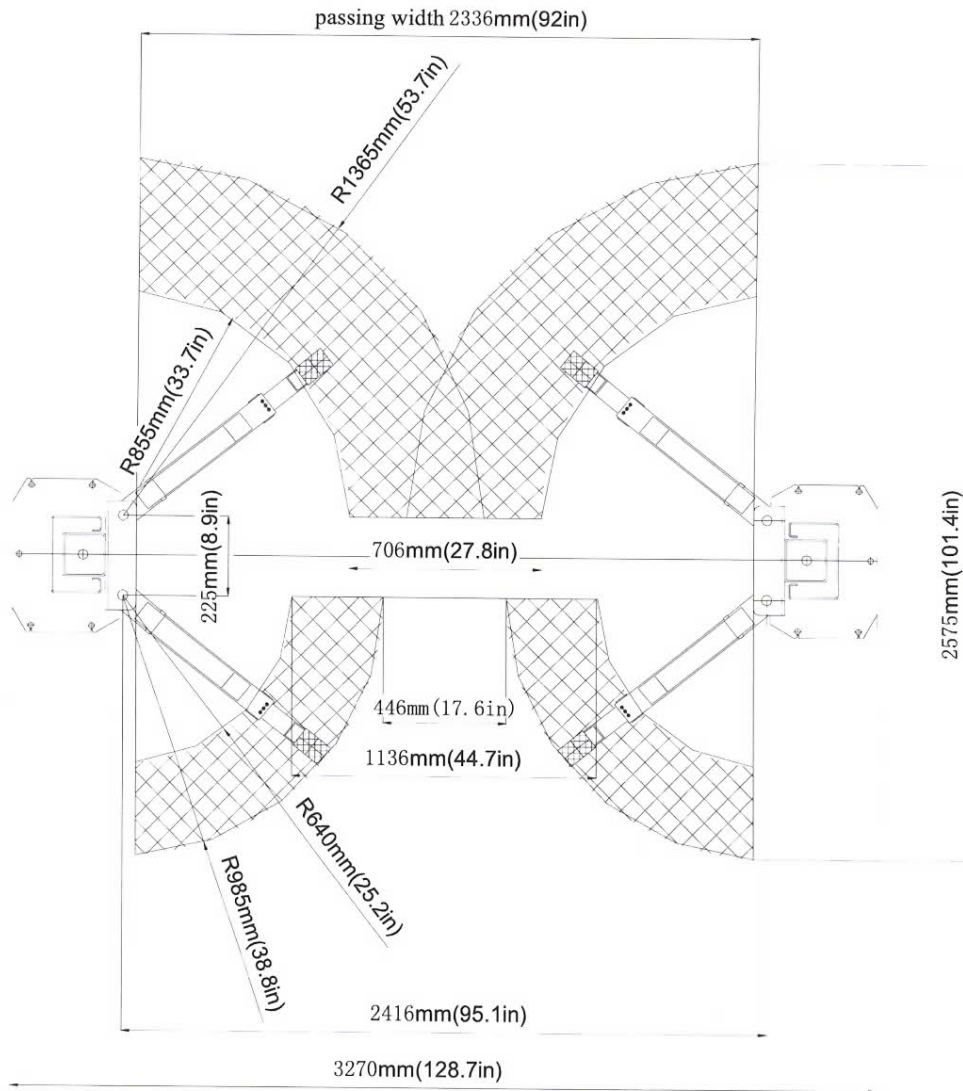

Fig. 2

## TLTE40SCA

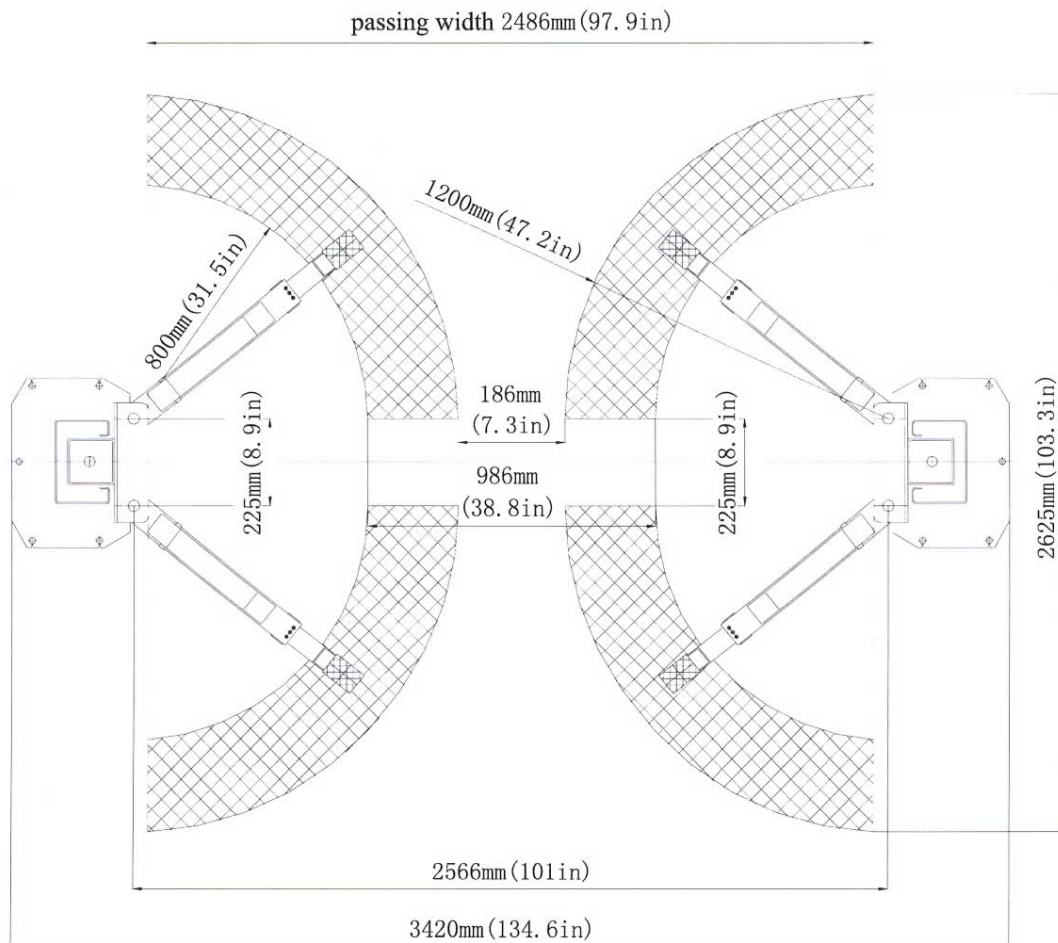

Fig. 3

## 3 Operation Description

### 3.1 Precautions for Operation

- Different vehicles have different center of gravity positions. First understand the position of center of gravity, and when the vehicle enters into the lift, make its center of gravity close to the plane formed by two columns. Adjust the swing arm, and make the lifting pad support onto the lifting point of the vehicle.
- For the lifting with top beam lift, observe the vehicle top position, and don't get close to the top beam to avoid causing the accident.
- Carefully read the warning symbol.
- The hydraulic valves have been adjusted before ex-factory, and the user can't make self-adjustment, otherwise it will be responsible for all the consequences generated.
- Based on the production needs, some specifications in the instruction manual are subjected to change without notice.

### 3.2 Preparation before Operation

- Lubricate contact surface of the carriage and corners of the column with general-purpose lithium grease. All sliding surface should be coated evenly from the top to bottom.
- Fill hydraulic oil N32 or N46 to the oil reservoir of the power unit.

### 3.3 Inspection before operation

- Check to see if the motor power is installed properly.
- Check to see if all the connection bolts are fastened.
- Press the UP button to start the motor, and the carriage rises. Release the UP button, and carriage will stop. To lower the carriage, first actuate the electromagnet by press the UNLOCK button. If it can't release the safeties, press the UP button to go up a little. Press and hold the UNLOCK button again, and then press the DOWN button, the carriage will lower. Release the two buttons (DOWN and UNLOCK), the carriage will stop lowering.

**⚠ Note: Don't operate the lift with damaged cables or damaged and missing part, until it is inspected and repaired by the professionals.**

### 3.4 Lifting the Vehicle

- Keep work area clean, don't operate the lift in cluttered work area.
- Lower the carriage to the lowest position.
- Reduce the swing arm to the minimum length.
- Swing the arm along the route of the vehicle
- Move the vehicle to the location between the two columns
- Swing the arm and put the lifting pad below the recommended lifting point, and adjust the height of lifting pad to touch lifting point of vehicle
- Press the UP button on the electric control box, slowly lift the vehicle to ensure the load balance, and then raise the lift to the required height.
- Release the UP button and the carriage will stop.
- Press the DOWN button to engage the safety lock of carriage. At this time, the vehicle can be repaired.



**Note:**

- ◇ *When lifting the vehicle, all the swing arms must be used.*
- ◇ *Before lifting the vehicle, check all the hydraulic hose*

*and fittings for oil leakage. In case of leakage, please don't use the lift. Remove the fitting with leakage and re-seal. Re-install the fitting and check if oil leakage still exists.*

- ◇ *After the vehicle is lifted, when adding or removing any major heavy object, use jack stand to maintain the balance of the vehicle.*

### 3.5 Lowering the Vehicle

- Clean the work area before lowering the vehicle.
- First press the UP button to raise the vehicle a little, then press and hold the UNLOCK button to disengage the safety lock, and then press DOWN button to lower the vehicle.
- Lower the vehicle till the swing arm down to the bottom and the lifting pads leave the vehicle chassis, and then release the two buttons.
- The swing arms under the vehicle must be fully shrunk



**Note:** *When the lift doesn't work, you must switch off the power.*

## 4 Hydraulic and Electrical System of the Equipment

### 4.1 Hydraulic System of the Lift

Diagram of the hydraulic system of floor-plate 2-post lift (TLTE32SBA/ TLTE40SBA)

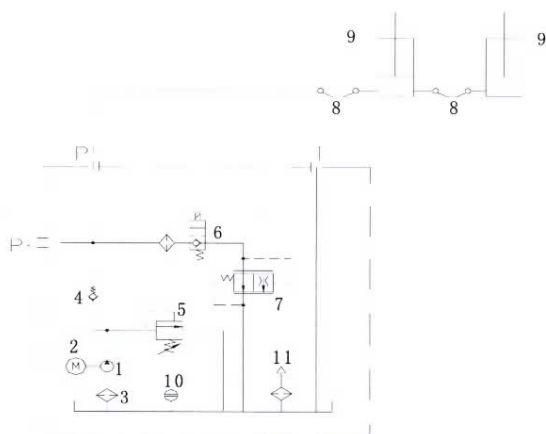

- 1- Gear pump, 2- Motor, 3- Oil filter, 4- Check-valve, 5- Safety valve, 6- Solenoid valve,
- 7- Servo flow-control valve, 8- Hose, 9- Hydraulic cylinder, 10- Level gauge, 11- Air filter

Fig. 5

The working principle of the hydraulic system is as follows:

When the UP button is pressed, the motor is started, driving the oil pump, sucking the hydraulic oil from the oil tank into the oil cylinder 9, forcing the piston rod move. At this time, the safety valve 5 is closed, and the Max working pressure is already adjusted before ex-factory. The safety valve can ensure the capacity of the rated load, but when the pressure in the system exceeds the limit, automatically overflow will be happened inside safety valve to protect the hydraulic system. Release the UP button to stop the oil supply and the lifting will stop. For lowering, press and hold the UNLOCK button, the electromagnetic safety lock mechanism will be released, meanwhile press the DOWN button, the solenoid valve 6 is actuated, the hydraulic oil flows back from the hydraulic cylinder into the oil tank through the solenoid valve 6 and flow-control valve 7, and the lift starts the lowering.

## 4.2 Electrical System of the Lift

### Diagram of the electrical system

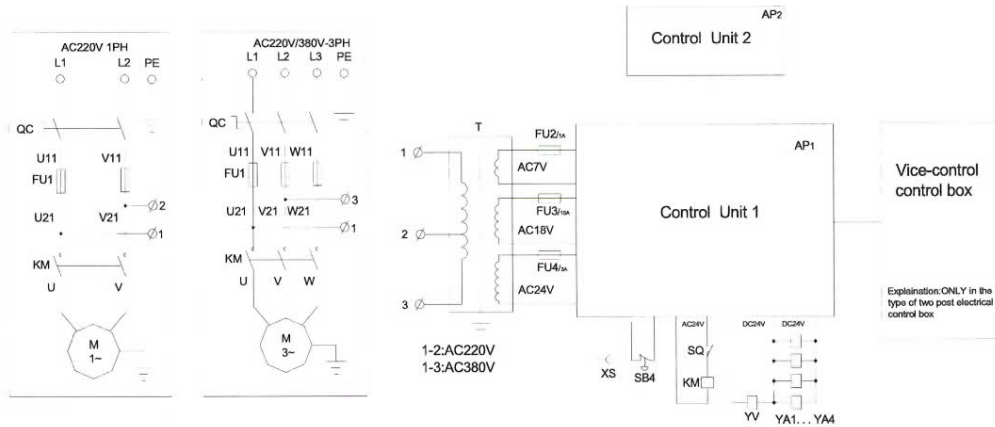

KM-Contactor; M-Motor; QC-Power switch; T-Transformer; SB1-UP button; SB4-STOP button; YA1、YA2、YA3、YA4-Electromagnet  
YV-Solenoid valve; SQ-Limit switch; XS-Socket of light; FU-Fuse

### Diagram of the wire connection

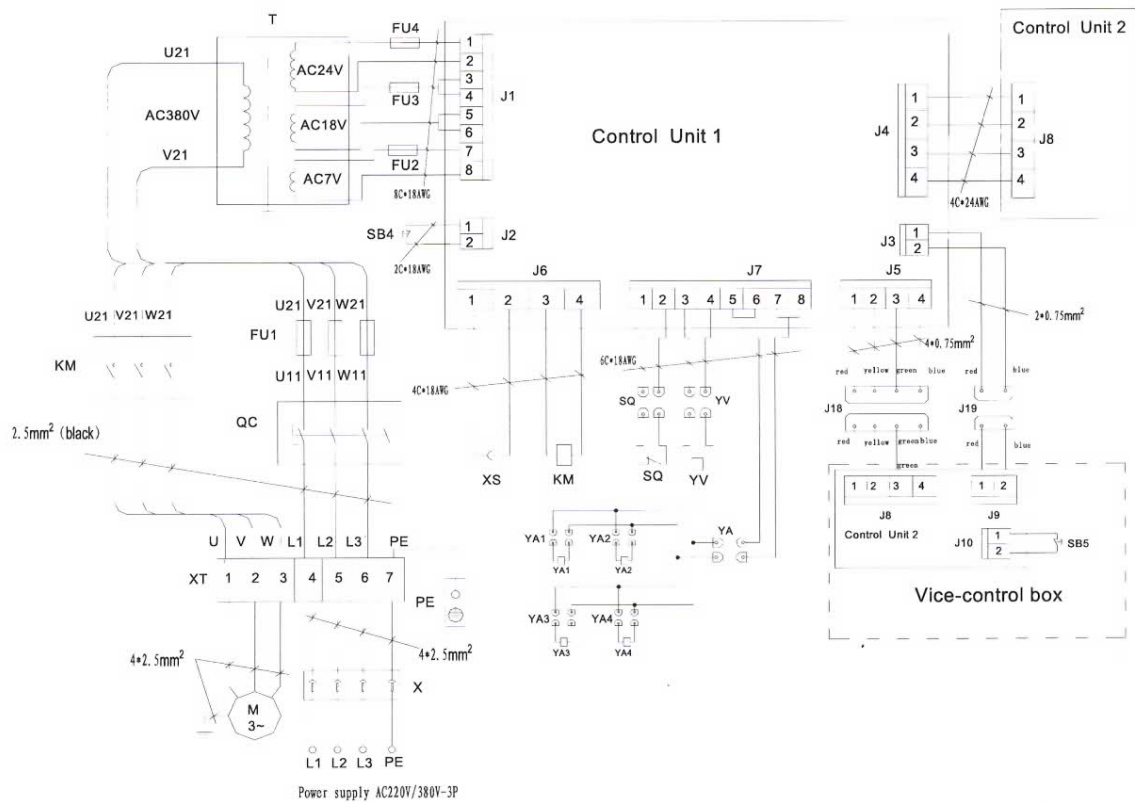

**⚠ NOTES:** This equipment needs NFB (non-fuse breaker) upon installation. This equipment does not

include this part, bought and installed by users. The NFB is 16A.

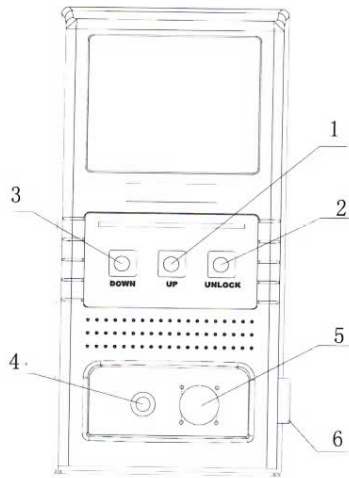

1. UP button    2. Unlock button    3. DOWN button  
 4. ES button    5. Socket for light    6. Power switch

## Adjustment procedure

- Check to see if the power supply is installed properly.
- Check to see if all the bolts are fastened.
- Press the UP button to start the motor, and the carriage rises. Release the UP button, and the carriage stops. To lower the carriage, first actuate the electromagnet by press the UNLOCK button. If it can't release the safeties, press the UP button to go up a little(10-20mm). Press and hold the UNLOCK button again, then press the DOWN button, the carriage will lower. Release the two buttons (DOWN and UNLOCK), the carriage will stop lowering. When the vehicle is raised at required height, press the DOWN button, making the electromagnet safety locked. Ensure the safe repairing under the vehicle.
- The hydraulic system may contain air due to new installation. To bleed the air, repeat the lifting and lowering for several times.  
The adjustment is completed.

## 5 Solutions to FAQ

Symptom	Reason	Solution
Motor not operation	<ul style="list-style-type: none"> <li>◆ Check the circuit breaker or fuse</li> <li>◆ Check the voltage to the motor</li> <li>◆ Check all the wire connection</li> <li>◆ Limit switch is failed</li> <li>◆ Motor wire is burnt</li> </ul>	<ul style="list-style-type: none"> <li>◆ Replace the burnt fuse or reset the circuit breaker</li> <li>◆ Supply correct voltage for motor</li> <li>◆ Repair all the wires</li> <li>◆ Replace the limit switch</li> <li>◆ Replace the motor</li> </ul>
Motor is running, but the lift can't be raised.	<ul style="list-style-type: none"> <li>◆ Motor rotation reversed</li> <li>◆ Solenoid valve body open.</li> <li>◆ Hydraulic pump sucks the air</li> <li>◆ Suction tube is separate from the hydraulic pump</li> <li>◆ Low oil level</li> </ul>	<ul style="list-style-type: none"> <li>◆ Change the motor rotating direction by changing wire connection.</li> <li>◆ Repair or replace the solenoid valve body</li> <li>◆ Fasten all the suction pipe fittings</li> <li>◆ Replace the suction tube</li> <li>◆ Add the oil into the oil tank</li> </ul>
Motor is running, the lift can be raised without load, but the vehicle can't be raised	<ul style="list-style-type: none"> <li>◆ Motor is running under low voltage</li> <li>◆ Impurities inside the solenoid valve body</li> <li>◆ Regulation pressure of safety valve is incorrect</li> <li>◆ Lift is overloaded</li> </ul>	<ul style="list-style-type: none"> <li>◆ Supply correct voltage to the motor</li> <li>◆ Remove impurities from the solenoid valve body.</li> <li>◆ Adjust the safety valve</li> <li>◆ Check the weight of the vehicle</li> </ul>
The lift is lowering slowly without pressing the down button	<ul style="list-style-type: none"> <li>◆ Impurities on the solenoid valve body.</li> <li>◆ External oil leakage</li> </ul>	<ul style="list-style-type: none"> <li>◆ Clean the solenoid valve body</li> <li>◆ Repair the external leakage</li> </ul>
The lifting speed is slow or oil flows out of the oil fill cap	<ul style="list-style-type: none"> <li>◆ Air and oil are mixed</li> <li>◆ Air and oil suction are mixed</li> <li>◆ Oil return pipe is loosened</li> </ul>	<ul style="list-style-type: none"> <li>◆ Replace the hydraulic oil</li> <li>◆ Fasten all the suction pipe fittings</li> <li>◆ Re-install the oil return pipe</li> </ul>
The lift can't rise horizontally	<ul style="list-style-type: none"> <li>◆ Balance cable is not adjusted properly</li> <li>◆ The lift is installed on the slop floor</li> </ul>	<ul style="list-style-type: none"> <li>◆ Adjust the balance cable to the proper tension</li> <li>◆ Shimming the columns to level the lift, If exceeding 12mm, pour new concrete floor and make it leveled. Refer to installation description.</li> </ul>
Anchor bolt is not fastened	<ul style="list-style-type: none"> <li>◆ Hole is drilled too big</li> <li>◆ Concrete floor thickness or fastening force is insufficient</li> </ul>	<ul style="list-style-type: none"> <li>◆ Pour the fast curing concrete into the big hole and reinstall the anchor bolt, or use new drill to drill the hole for re-positioning the lift</li> <li>◆ Cut open the old concrete and make new concrete slab for the lift. Refer to installation description.</li> </ul>

## 6 Repair and Maintenance

### Keep clean

- This unit should be cleaned with dry cloth frequently to keep it clean. Before cleaning, first switch off the power to ensure the safety.
- The working environment of this unit should be clean. In case of dust in the working environment, it will speed up the parts wearing and shorten the service life of the lift.

### Every day:

- Before the operation, carefully check the safety mechanism of the lift to ensure the electromagnet suction and release action is proper, and the safety plate is in good condition. When finding any abnormal situation, make adjustment, repair or replacement immediately.
- Check to see if the connection between hydraulic cylinder and carriage is proper, if the connecting nut between the steel chain and carriage is loose or falling. Refer to Fig. 6.
- Check to see if the steel cable connection is proper, and if the tension is at the optimum status.

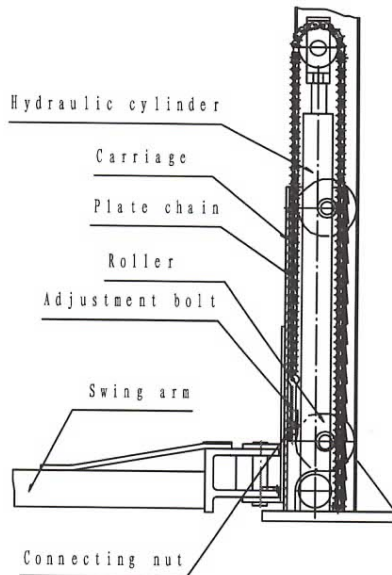

Fig. 6

### Every month:

- Retighten the anchor bolts.
- Lubrication chains/cables.
- Check all the chain connectors, bolts and pins to ensure correct installation
- Check all the hydraulic lines for wearing
- Check to see if the carriage and the inner side of the column are properly lubricated. Use high-quality heavy lubrication grease (lithium based lubrication grease).

**⚠ Note: All the anchor bolts should be tightened completely. If any screw doesn't function for some reason, the lift can not be used until the bolt is replaced**

### Every six months

- Check all the movable parts for possible wearing, interference or damage.
- Check the lubrication of all the pulleys. If the pulley has dragging during the lifting and lowering, add appropriate lubricant to the wheel axle.
- When necessary, check and adjust the balancing tension to ensure the horizontal lifting and lowering.
- Check the verticality of the column.

**⚠ Note: The inner corner of each column should be lubricated with lubricant, to minimize the roller friction and ensure the smooth and even lifting.**

### Maintenance of hydraulic system:

- Clean and oil change: In the six months after initial use of this unit, clean the hydraulic oil tank and replace the oil, later clean the hydraulic system once a year, and replace the oil. See Fig. 7.
- Replace the seal: After this unit is put into operation for certain period, if finding the oil leakage, carefully check it; if the leakage is due to the wearing of sealing materials, immediately replace the worn one based on the original spec. See Fig. 7



Diagram of hydraulic line of clear-floor 2-post lift

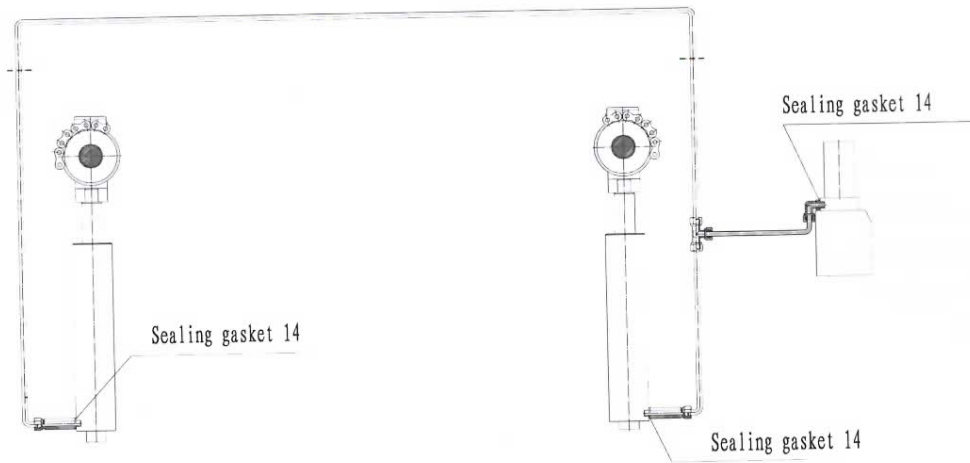

Fig. 7

### Wearing Parts

No.	Name	Model	Spec	Qty	Remark
1	O rubber sealing ring	GB3452.1-92	48.7×5.3	1	
2	Dust proof ring		J40	1	
3	Shaft sealing ring		USI53×63×6	1	
4	Rubber pad			4	Self-made part

## 7 Storage and Scrap

### 7.1 Storage

When the equipment requires long-time storage:

- Disconnect the power supply
- Lubricate all the parts requiring lubrication: mobile contact surface of the carriage, etc.

- Empty all the oil/liquid storage units
- Put the plastic cover over the equipment for dust protection

### 7.2 Scrap

When the equipment service life is expired and can no longer be used, disconnect the power supply, and properly dispose of as per relevant local regulations.

## Grease and hydraulic oil for lift

### 2# lithium based lubrication grease

Item	Quality Index
Conical degree (1/10mm)	278
Dripping point °C	185
Corrosion (T2 copper sheet, 100 °C, 24h)	No change for copper sheet
Copper mesh oil split (100°C, 22h) %	4
Evaporation (100°C, 22h) %	2
Oxidation stability (99°C, 100 h)	0.2
Anti-corrosion (52°C, 48)	Class 1
Impurity (microscope) / (pcs/cm <sup>3</sup> )	
Above 10μm no more than	5000
Above 25μm no more than	3000
Above 75μm no more than	500
Above 125μm no more than	0
Similar viscosity ( -15 °C , 10s <sup>-1</sup> ) ,(Pa·s) no more than	800
Water spray loss (38°C, 1h) (%) no more than	8

### N32 hydraulic oil (used for low ambient temperature)

Item	Quality Index
Kinematic viscosity 40°C	28.8~35
Pour point /°C no higher than	-15
Flash point /°C no lower than	175

### N46 hydraulic oil (used for high ambient temperature)

Item	Quality Index
Kinematic viscosity 40°C	41.4~50.6
Pour point /°C no higher than	-9
Flash point /°C no lower than	185

## Warranty

This warranty clause is only applicable for the users and distributors who purchase LAUNCH products through normal sales procedure.

Within 12 months from the date of goods delivery, Launch will make warranty on its mechanical and electrical components due to material or process defects. This warranty does not extend to defects or damage caused by ordinary wear, abuse, unauthorized change, misuse, shipping damage, or lack of required maintenance. The compensation for the automobile damage caused by our equipment defect is only restricted to repair, and Launch doesn't undertake any indirect or incidental loss. Launch will judge the equipment damage attribute based on its stipulated inspection method. None of Launch's distributors, staffs or commercial representatives has the right to make any confirmation, prompting or commitment related to Launch's products.

## Disclaimer

The above warranty clause can replace any other forms of

warranty clauses.

## Order notice

The parts and optional accessories that can be replaced can be directly ordered with suppliers authorized by Launch. When placing the order, please indicate:

Order quantity

Parts number

Parts name

## Customer service

In case of any problems during the operation of the equipment, please call: 86-21-69573179 or toll free number +86-4000666666. The following is the address of the lift production base of Launch Shanghai:

No. 661 Baian Road, International Automobile City Auxiliary Parts Park, Anting Town, Jiading District, Shanghai City

Launch Shanghai Machinery Co., Ltd.

Postcode: 201805

Launch Shanghai Machinery Co., Ltd.

Address: No. 661 Baian Road, International Automobile City Auxiliary

Parts Park, Anting Town, Jiading District, Shanghai City

Postcode : 201805      Tel: +86-400-0666666;

Fax: +86-21-69573108      Email: Launch.sh@cnlaunch.com